



CITROEN BERLINGO
PEUGEOT PARTNER

11/1996 - 2008

Cat. No. **C/012**

E20

55R01/07*005578*00

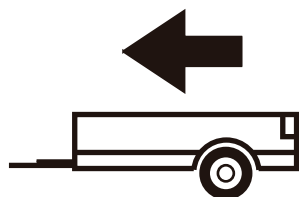

1100kg



70kg

D = 7,00kN

D (kN) =



MAX kg

x

MAX kg

x 0,00981



MAX kg

+

MAX kg



IMIOLA HAK-POL

96-111 KOWIESY, CHOJNATA 23A, POLAND

Tel. + 48 46 831 73 31, fax +48 831 74 29

e-mail: office@imiola.pl, www.imiola.pl

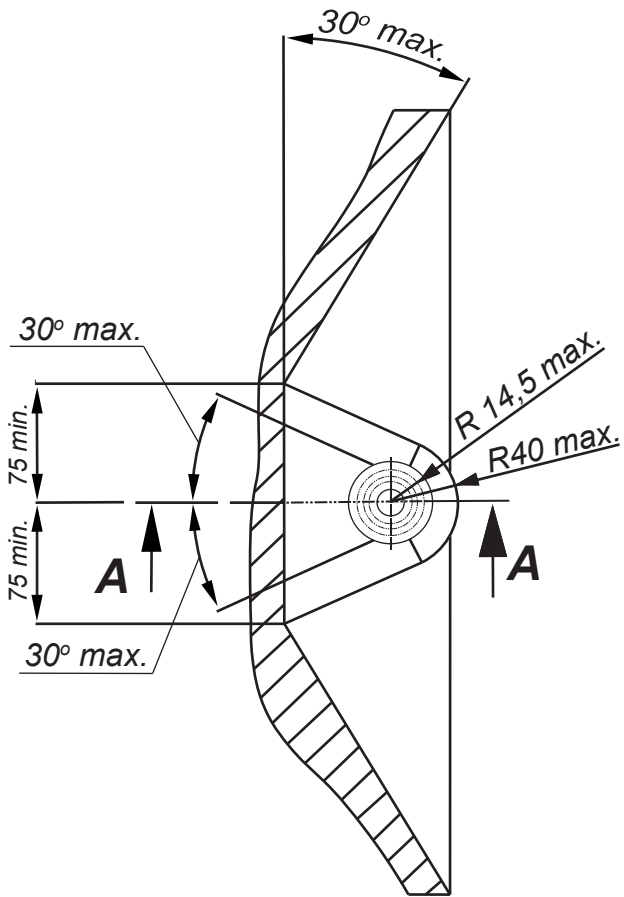

PRZEKRÓJ A-A

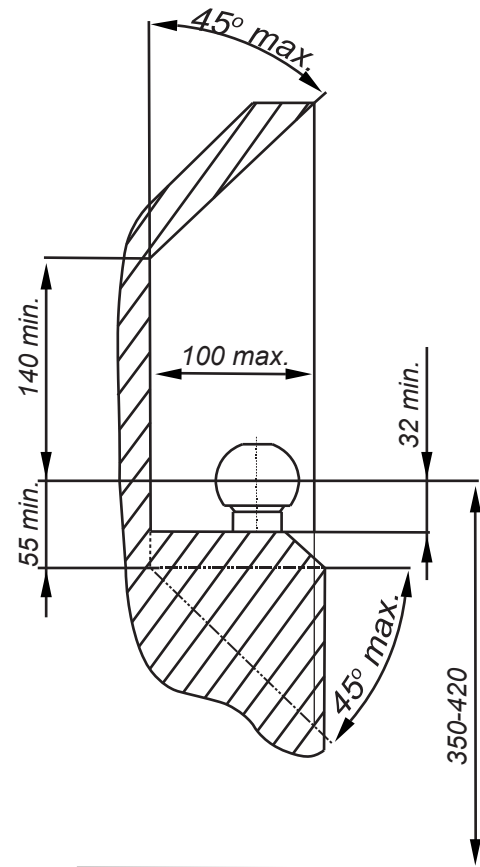

PL Należy zagwarantować przestrzeń swobodną według załącznika VII, rysunek 25a/b Regulaminu EKG ONZ 55.01 przy dopuszczalnym ciężarze całkowitym pojazdu.

F L'espace libre doit être garanti conformément à l'annexe VII, illustration de la réglementation 55.01 CE pour un poids total en charge autorisé du véhicule.







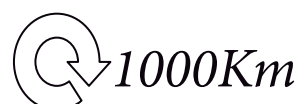

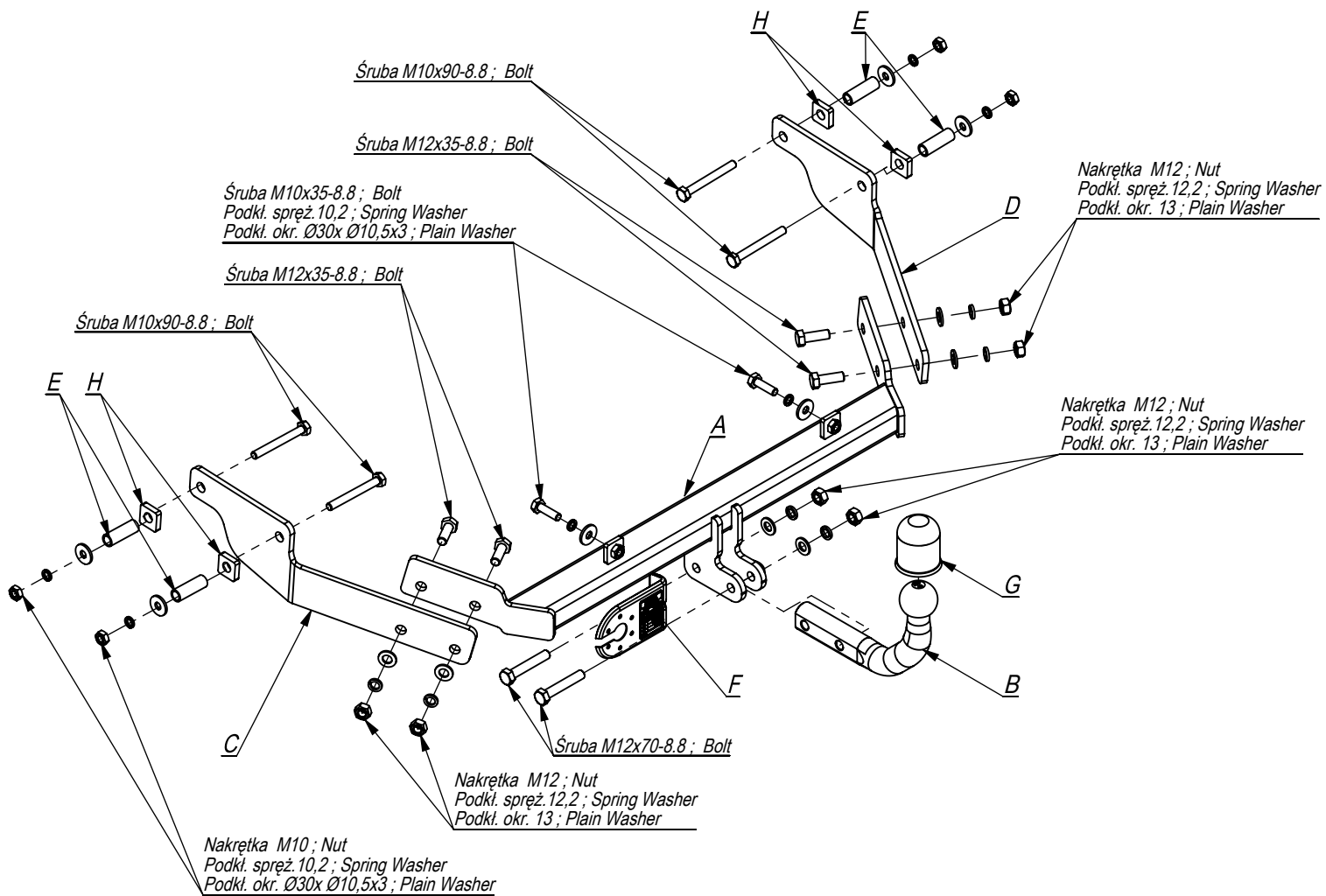

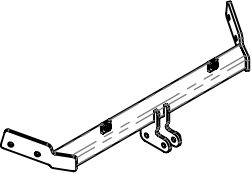
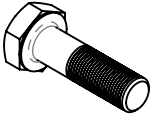
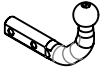
GB The clearance specified in appendix VII, diagram 25a/b of Regulation No. 55.01 UN EU must be guaranteed at laden weight of the vehicle.

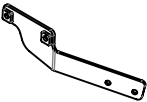
D Der Freiraum nach Anhang VII, Abbildung 25a/b der Vorschriften 55.01 EG ist zu gew 25a/b abzuwehren bei zulässigem Gesamtgewicht des Fahrzeuges.

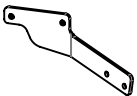
Moment skręcający dla śrub i nakrętek (8.8) Torque settings for nuts and bolts (8.8)	
M8	25Nm
M10	55Nm
M12	85Nm
M14	135Nm
M16	195Nm



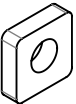

	A	x1		M12x70	2
				M12x35	4
				M10x90	4
				M10x35	2
	B	x1		M12	6
				M10	4
	C	x1		Ø30xØ10,5x3	6
	D	x1		13	6
Ø17,2x2,3x50 	E	x4		12,2	6
	F	x1		10,2	6
	G	x1		H	x4

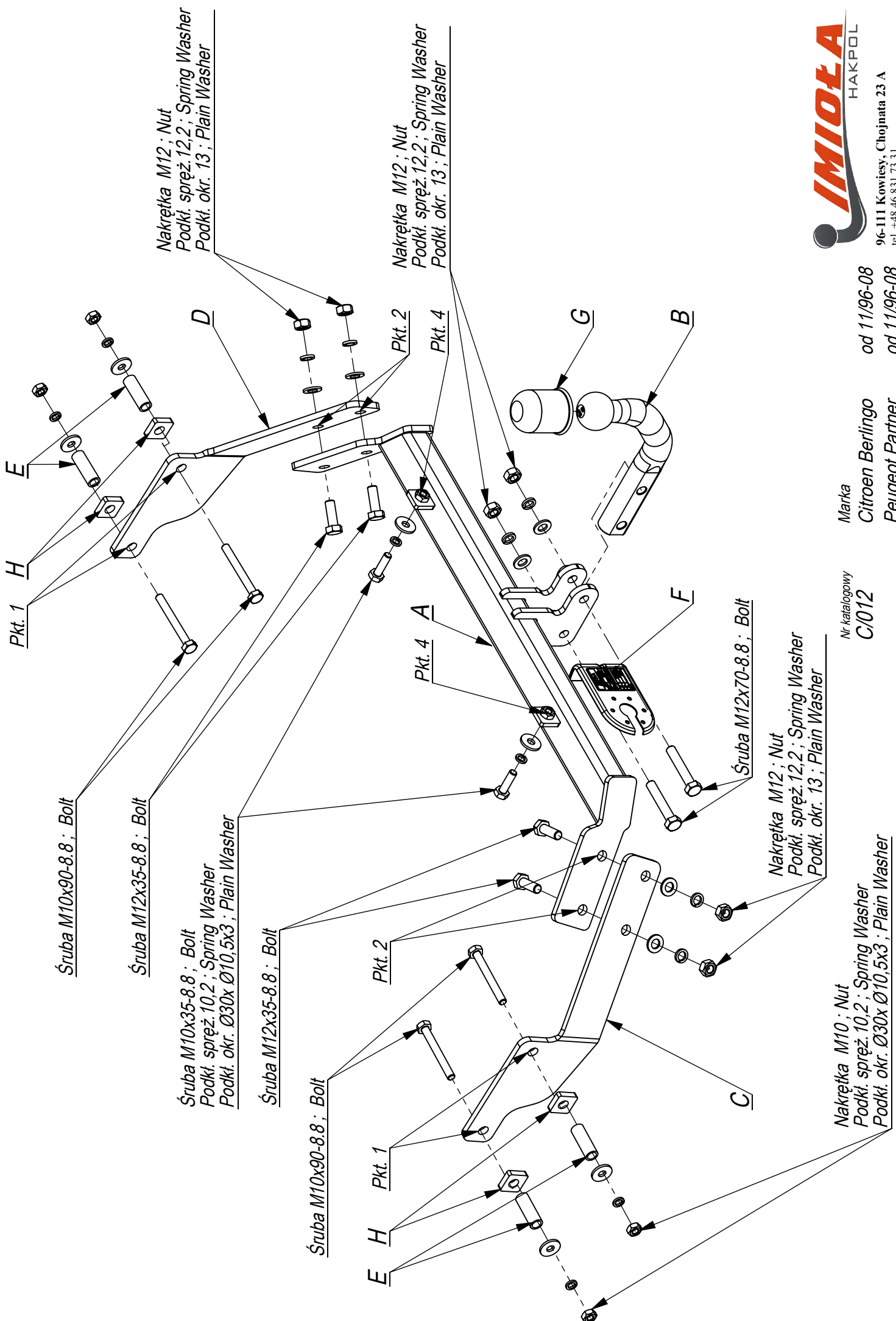

- Odkręcić koło zapasowe.
- W technologiczne otwory, w podłużnicach włożyć tuleje dystansowe.
- Elementy haka C i D przykręcić lekko do podłużnic śrubami M10x90 8.8 (pkt 1).
- Przez otwory w tylnym pasie przykręcić lekko belkę haka śrubami M10x35 8.8 (pkt 4).
- Elementy haka C i D przykręcić do belki haka A śrubami M12x35 8.8 (pkt 2).
- Dokręcić wszystkie śruby z momentem wg tabeli.
- Przykręcić kulę i blachę gniazda elektrycznego śrubami M12x70 8.8 (pkt 3).
- Podłączyć instalację elektryczną.
- Zamontować koło zapasowe.

- Unscrew the spare wheel.
- Insert distance sleeves in the technological holes of the metal clamps.
- Screw slightly elements C and D to the metal clamps with bolts M10x90 8.8 (point 1).
- Screw slightly the main bar, through the holes in the rear belt, with bolts M10x35 8.8 (point 4).
- Screw the elements C and D to the main bar A with bolts M12x35 8.8 (point 2).
- Tighten all the bolts according to the torque setting- see the table.
- Fix the ball and electric plate with bolts M12x70 8.8 (point 3).
- Connect the electric wires.
- Assemble the spare wheel.

- Desserrer la roue de secours,
- Placer les douilles d'écartement dans les ouvertures de longerons,
- Serrez légèrement les éléments de Rochet C et D aux longerons par les boulons M10x90 8.8 (point 1).
- Serrez légèrement le socle du crochet par les ouvertures de ceinture arrière par les boulons M10x35 8.8 (point 4).
- Serrez les éléments du crochet C et D au socle du Rochet A par les boulons M12x35 8.8 (point 2).
- Serrer tous les boulons avec un couple de serrage selon tableau,
- Visser le crochet d'attelage et socle de prise électrique par les boulons M12x70 8.8 (point 3).
- Raccorder le circuit électrique.
- Desserrer la roue de secours.

- Das Ersatzrad abschrauben.
- In die vom Werk aus vorhandenen Öffnungen die Distanzhülsen stecken.
- Die Tragteile C und D an die Längsträger mit den Schrauben M10x90 8.8 (Punkt 1) anschrauben.
- Durch die Öffnungen im hinteren Karosseriestreifen, den Balken mit den Schrauben M10x35 8.8 (Punkt 4) locker anschrauben.
- Die Tragteile C und D an den Querbalken A mit den Schrauben M12x35 8.8 (Punkt 2) anschrauben.
- Alle Schrauben mit dem in der Tabelle angegebenen Drehmoment festschrauben.
- Die Kugel und die Steckdosenhalterung mit den Schrauben M12x70 8.8 (Punkt 3) anschrauben.
- Die Elektroinstallation anschließen.
- Das Ersatzrad einbauen.

- Desenroscar la rueda de recambio.
- En los agujeros tecnológicos en los largueros deben insertarse las mangas separadoras. A tal preparados largueros debe atornillar los componentes del gancho D y C por medio de tornillos M10x90 8.8 (p. 1).
- Fijar la barra del gancho a la correa trasera con tornillos M10x35 (p.4)
- Atornillar la viga del enganche A a los elementos C y D con tornillos M12x35 8.8 (p. 2).
- Apretar todos los tornillos con el par según la tabla anterior.
- Conectar la instalación eléctrica.
- Atornillar la bola y el soporte de la toma de corriente.(p.3)
- Enroscar la rueda de recambio.

