



10/2004 - 2008

CITROEN C-5 II 5d.

Cat. No. **C/022**

e20

e20*94/20*0722*00

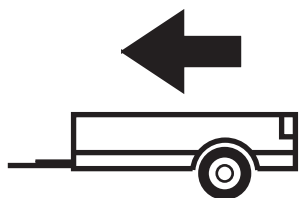

1600kg

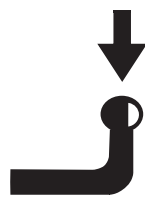

75kg

D = 9,17kN

D (kN) =



MAX kg

x

MAX kg

x 0,00981



MAX kg

+

MAX kg



IMIOLA HAK-POL

96-111 KOWIESY, CHOJNATA 23A, POLAND

Tel. + 48 46 831 73 31, fax +48 831 74 29

e-mail: office@imiola.pl, www.imiola.pl



PRZEKRÓJ A-A

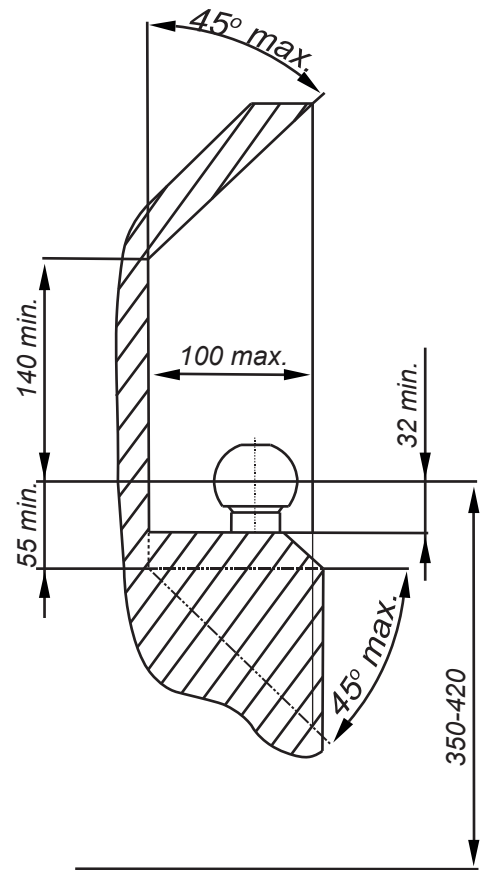

PL Należy zagwarantować przestrzeń swobodną według załącznika VII, rysunek 25a/b Regulaminu EKG ONZ 55.01 przy dopuszczalnym ciężarze całkowitym pojazdu.

F L'espace libre doit être garanti conformément à l'annexe VII, illustration de la réglementation 55.01 CE pour un poids total en charge autorisé du véhicule.







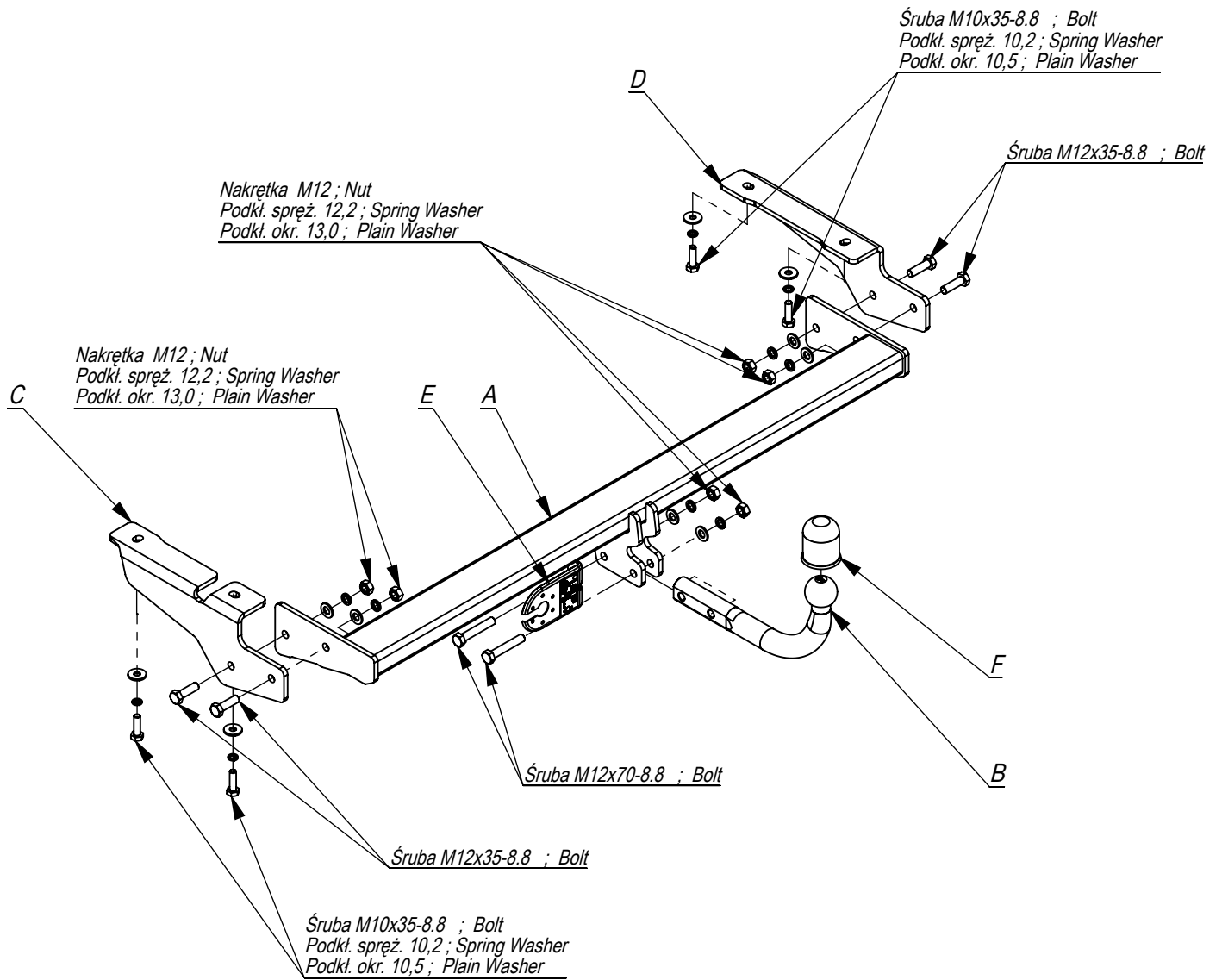

GB The clearance specified in appendix VII, diagram 25a/b of Regulation No. 55.01 UN EU must be guaranteed at laden weight of the vehicle.

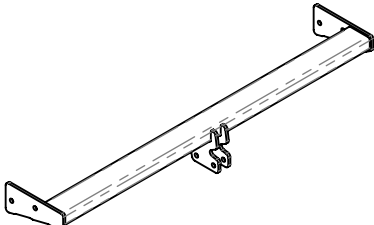
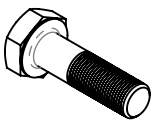
D Der Freiraum nach Anhang VII, Abbildung 25a/b der Vorschriften 55.01 EG ist zu gew 25a/bahrleisten bei zulässigem Gesamtgewicht des Fahrzeuges.

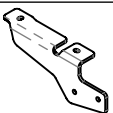
Moment skręcący dla śrub i nakrętek (8.8) Torque settings for nuts and bolts (8.8)	
M8	25Nm
M10	55Nm
M12	85Nm
M14	135Nm
M16	195Nm

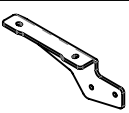



	A	x1		M12x70	2
				M12x35	4
				M10x35	4
	B	x1		M12	6
	C	x1		13	6
				10,5	4
	D	x1		12,2	6
				10,2	4
	E	x1			
	F	x1			

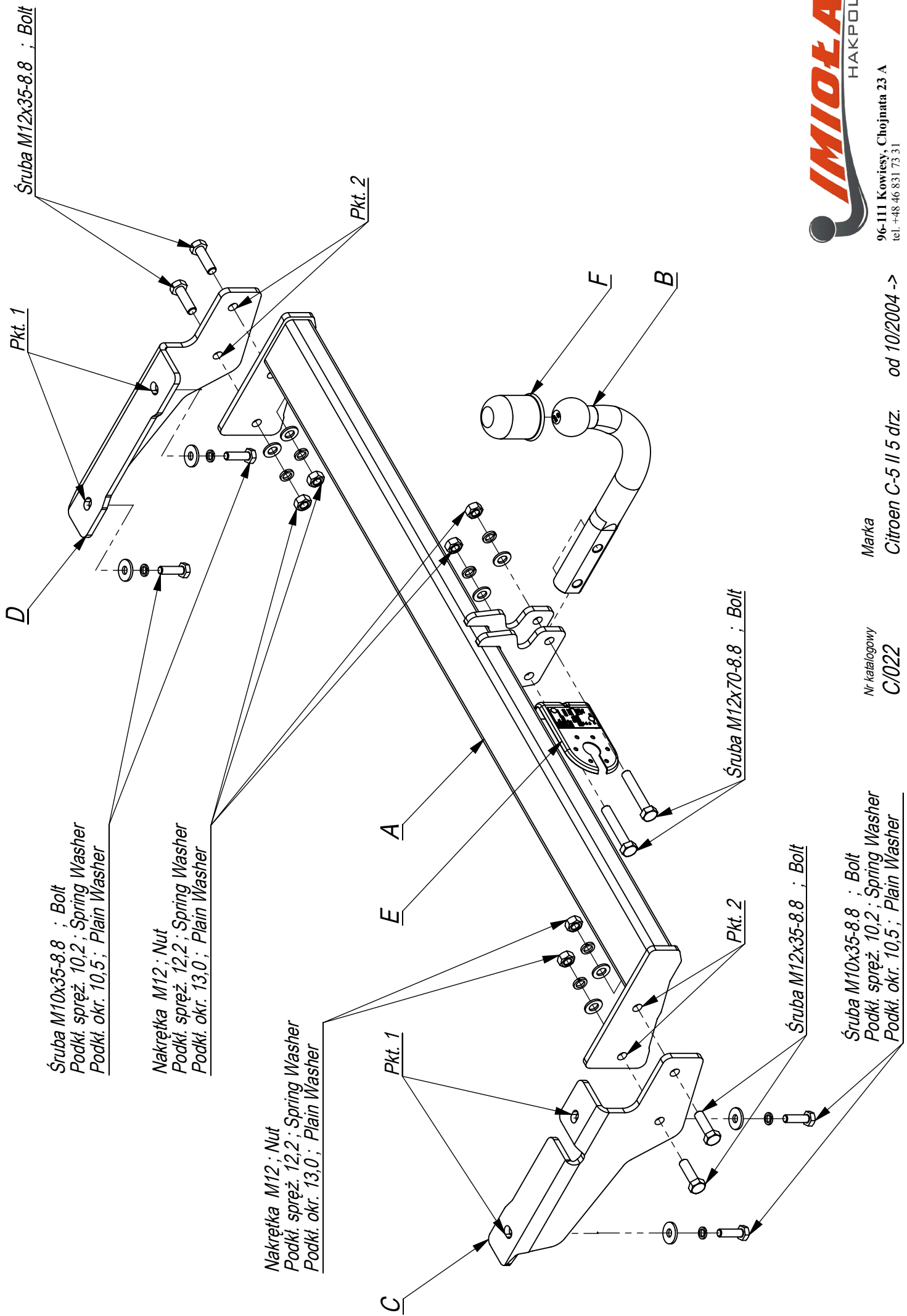

Śruba M12x35-8.8 ; Bolt

Pkt. 2

Pkt. 1

D

F

B

A

E

Śruba M12x70-8.8 ; Bolt

Pkt. 2

Pkt. 1

Śruba M12x35-8.8 ; Bolt

Śruba M10x35-8.8 ; Bolt

Podkł. spręż. 10,2 ; Spring Washer

Podkł. okr. 10,5 ; Plain Washer

Śruba M10x35-8.8 ; Bolt
Podkł. spręż. 10,2 ; Spring Washer
Podkł. okr. 10,5 ; Plain Washer

Nakrętka M12 ; Nut
Podkł. spręż. 12,2 ; Spring Washer
Podkł. okr. 13,0 ; Plain Washer

Nakrętka M12 ; Nut
Podkł. spręż. 12,2 ; Spring Washer
Podkł. okr. 13,0 ; Plain Washer

Śruba M10x35-8.8 ; Bolt
Podkł. spręż. 10,2 ; Spring Washer
Podkł. okr. 10,5 ; Plain Washer



96-111 Kowiesy, Chojnata 23 A
tel. +48 46 831 73 31

Marka

Citroen C-5 II 5 drz. od 10/2004 ->

Nr katalogowy

C/022

- Do prawej podłużnicy przykręcić lekko w technologiczne otwory element haka C śrubami M10x35 8.8 .
- Do lewej podłużnicy przykręcić lekko w technologiczne otwory element haka D śrubami M10x35 8.8 .
- Do elementów haka C i D przykręcić belkę haka A śrubami M12x35 8.8 .
- Dokręcić wszystkie śruby z momentem według tabeli.
- Przykręcić kulę i podstawę gniazdka elektrycznego śrubami M12x70 8.8.
- Podłączyć instalację elektryczną.

- Screw slightly element C to the right metal clamp in the technological holes with bolts M10x35 8.8 .
- Screw slightly element D to the left metal clamp in the technological holes with bolts M10x35 8.8 .
- Screw the main bar A to the elements C and D with bolts M12x35 8.8 .
- Tighten all the bolts according to the torque setting- see the table.
- Fix the ball and electric plate with bolts M12x70 8.8.
- Connect the electric wires.

- Visser légèrement l'élément C à la longeron droite dans les trous technologiques, à l'aide des boulons M10x35 8.8 .
- Visser légèrement l'élément D à la longeron gauche dans les trous technologiques, à l'aide des boulons M10x35 8.8 (point 2).
- Serrer la poutre du crochet d'attelage avec les éléments C et D à l'aide des boulons M12x35 8.8 .
- Serrer tous les boulons avec un couple de serrage selon tableau.
- Visser le crochet d'attelage et socle de prise électrique à l'aide des boulons M12x70 8.8.
- Raccorder le circuit électrique.

- An den rechten Längsträger durch die vom Werk aus vorhandenen Öffnungen das Tragteil C mit den Schrauben M10x35 8.8 locker anschrauben.
- An den linken Längsträger durch die vom Werk aus vorhandenen Öffnungen das Tragteil D mit den Schrauben M10x35 8.8 locker anschrauben.
- An die Tragteile C und D den Querbalken A mit den Schrauben M12x35 8.8 anschrauben.
- Alle Schrauben mit dem in der Tabelle angegebenen Drehmoment festziehen.
- Die Kugel und die Steckdosenhalterung mit den Schrauben M12x70 8.8 anschrauben.
- Die Elektroinstallation anschließen.

- Atornillar el elemento D de la bola de remolque usando los tornillos M10x35 8.8
- Atornillar el elemento C usando los tornillos M10x35 8.8
- Atornillar la viga de la bola de remolque A con los elementos C,D , usando tornillos M12x35 8.8.
- Apretar todos los tornillos con el par según la tabla anterior.
- Apretar el parachoques.
- Apretar la bola y la placa eléctrica con tornillos M12x70 8.8. (p. 3).
- Conectar la instalación eléctrica.

